

2" acrobat LED Wall Wash

Remodel Housing

Round or Square / Trimmed or Trimless

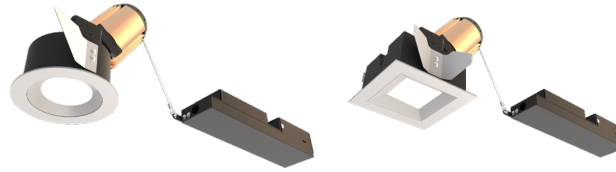

Wattage	CCT	Delivered Lumens	Efficacy
10W	3000K	509lm	51lpw
15W	3000K	758lm	51lpw
20W	3000K	900lm	45lpw

Lumens will vary depending on CCT & optic

Description

- Acrobat wall wash delivers uniform vertical and horizontal wall distribution through a 2" aperture.
- No ceiling access required.

Field Replaceable LED Light Engine

- 10W, 15W or 20W LED with 2 SDCM binning
- 2700K, 3000K, 3500K or 4000K at 90 CRI
- 50,000 hours at 70% lumen maintenance (L70)

Field Replaceable Dimming Driver

- Power factor > 0.9, 50/60Hz
- Multiple dimming drivers available
- Complies with IEEE62.41 surge protection

Adjustability

Locking 360° horizontal rotation. Adjust to 0° for spacing of 1.5 feet from wall and fixture opening center and 1.5 feet from fixture opening center to fixture opening center. Adjust to 5° for spacing of 2 feet from wall and fixture opening center and 2 feet from fixture opening center to fixture opening center. (Note: 2" ceiling thickness limits mechanism to 25° tilt).

Housing

Non-IC rated housing must be kept a minimum of 3" from insulation. 18 gauge galvanized steel housing and junction box with (3) 1/2" trade size knockouts. Includes (2) steel compression clips for installation below the ceiling. Max. ambient temperature: 104°F (40°C)

Ceiling Thickness

- Accommodates ceiling thickness from 1/2" to 2"
- Delivered lumens are maintained through entire range

Trim Style

- Round spun aluminum cut angle trim in anodized finishes available, consult factory for custom finishes
- Square die-cast aluminum cut angle trim in powder coat finishes available, consult factory for custom finishes
- Trimless mud plate option available

Emergency

Remote inverter operates for 90 minutes with remote test switch available, requires above ceiling access.

Listing/Warranty

- Patent pending
- Five (5) year limited warranty
- UL listed to US and Canadian standards for damp locations



Housing Order Matrix (Example: A2-RM10S-RWH00)

Installation Type	Wattage	Driver	Aperture	Flange Finish	Rev
A2-RM (Non-IC)	10 (10W) 15 (15W) 20 (20W)	S^{1,2} (ERP, Universal Dim, Triac/ELV/0-10V 1% 120-277V) SR1¹ (Remote ERP, Universal Dim, Triac/ELV/0-10V 1% 120-277V)	-R (Round) -S (Square)	WH (White) BL (Black) SA (Satin Aluminum) BZ (Bronze) TL (Trimless)	00

1. Forward and reverse phase dimming at 120V only
2. Driver is accessible from below ceiling

Trim Order Matrix (Example: A2-7RWH2750-00)

Trim	Aperture	Reflector Finish	CCT / CRI	Optic	Rev
A2-7	R (Round) S (Square)	WH (White) CA² (Clear Alzak) BL (Black) SA (Satin Aluminum) BZ (Bronze)	27 (2700K / 90 CRI) 30 (3000K / 90 CRI) 35 (3500K / 90 CRI) 40 (4000K / 90 CRI)	50 (Wall Wash)	-00

2. Available in round aperture only

Accessories

ABAT-RGNPLT-RND	(Round Rough-in Plate)
ABAT-RGNPLT-RND10	(Round Rough-in Plate, 10pcs)
ABAT-RGNPLT-RND5	(Round Rough-in Plate, 5pcs)
ABAT-RGNPLT-SQ	(Square Rough-in Plate)
ABAT-RGNPLT-SQ10	(Square Rough-in Plate, 10pcs)
ABAT-RGNPLT-SQ5	(Square Rough-in Plate, 5pcs)

Emergency

EM-1000	(25W LED Remote Inverter)
EM-1002	(10W LED Remote Emergency Driver)
EM-1003	(35W LED Remote Inverter)
EM-1004	(50W LED Remote Inverter)

2" acrobat LED Wall Wash

Remodel Housing

Round or Square / Trimmed or Trimless

Catalog #:

Type:

Project:

Date:

Notes:

Housing Dimensions

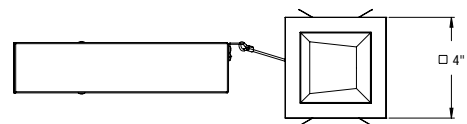
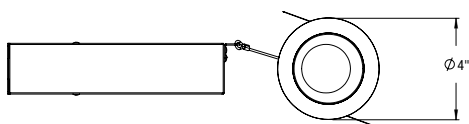
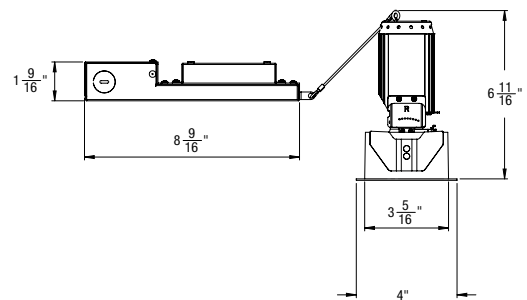
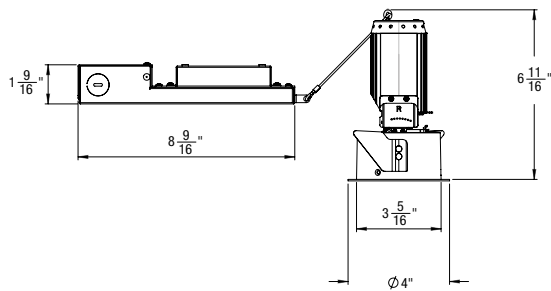
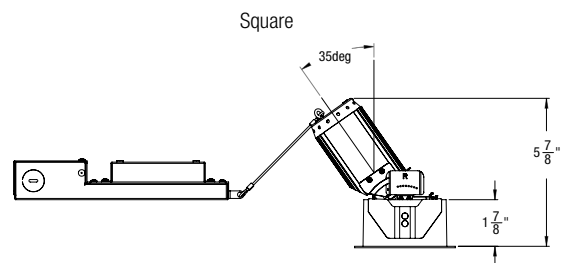
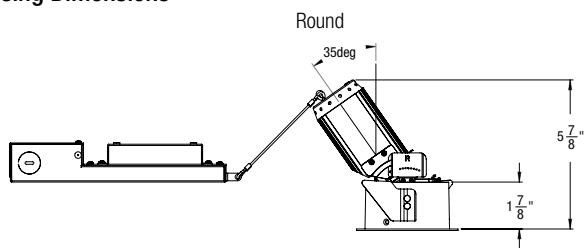

Ceiling Cut-out: 3-3/8" Ø

Ceiling Cut-out: 3-3/8" x 3-3/8"

Trim Dimensions

Round Trimmed

Round Trimless

Square Trimmed

Square Trimless

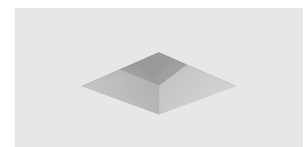
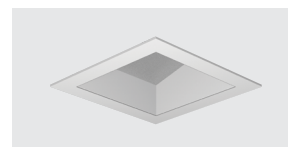
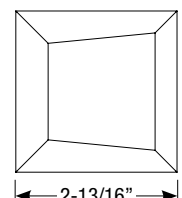
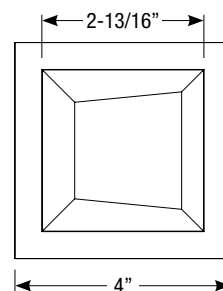
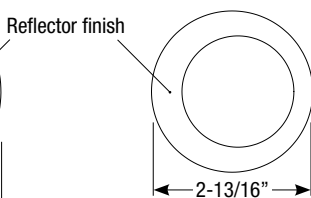
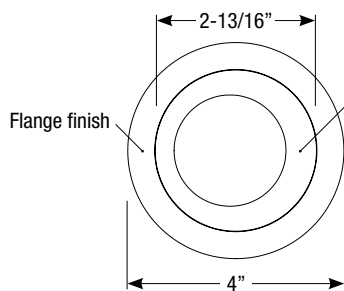
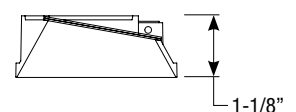
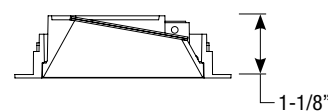
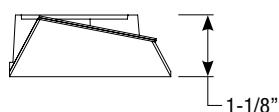
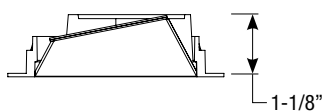

Spec-00099 Revised 10/24/2022